

# REJÄL

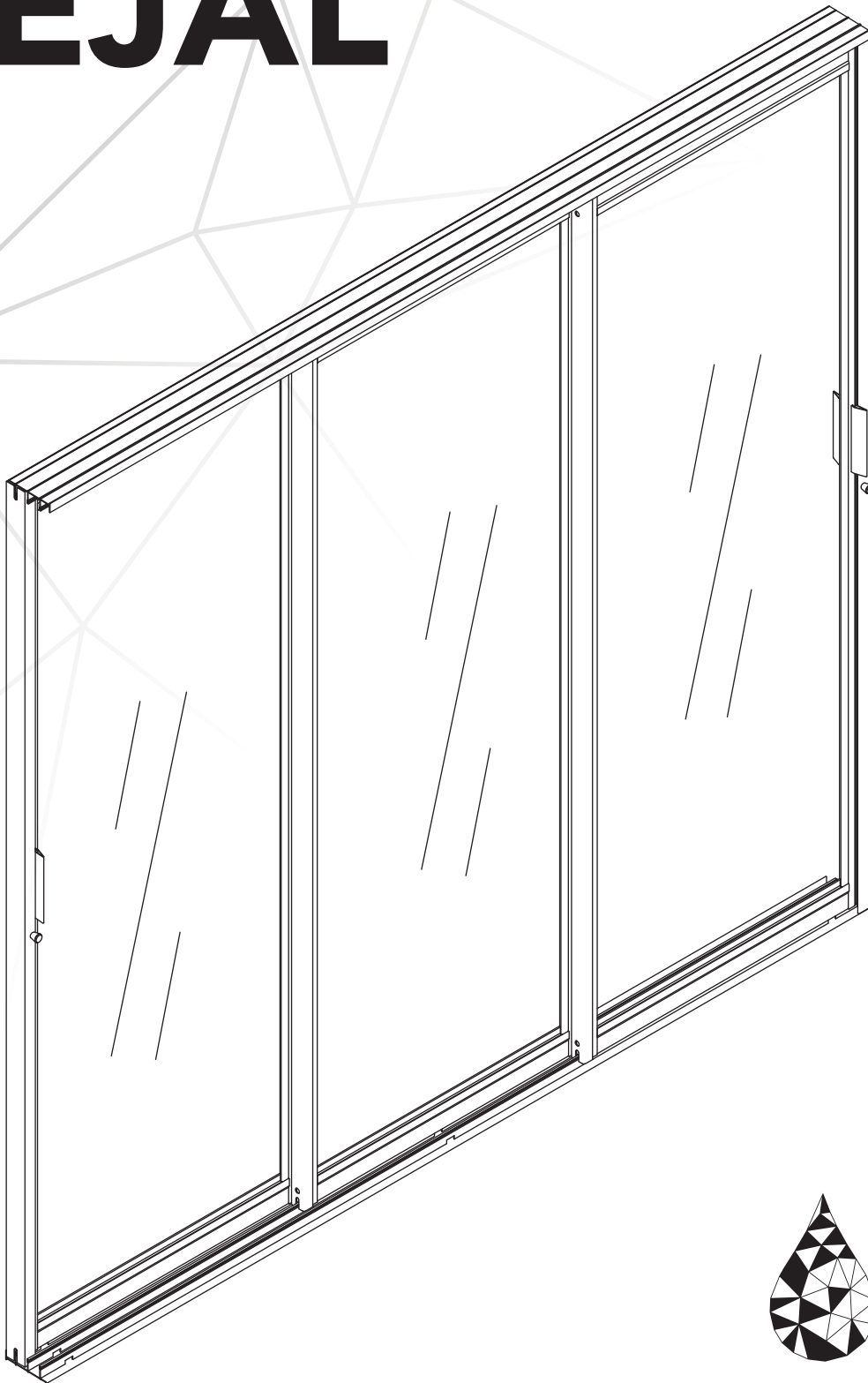

EN 12150-2:2004 (2020)

landskap.®

OF SWEDEN



Copyright ©2020 Bygghemma Sverige AB. Original content rights reserved. All product names, logos, and brands are property of their respective owners.



Information contained within this document was considered accurate at the time of publication, but may be subject to revision.



EN	<b>TABLE OF CONTENTS</b>	
SV	<b>INNEHÅLLSFÖRTECKNING</b>	
NO	<b>INNHOLDSFORTEGNELSE</b>	
DK	<b>INDHOLDFORTEGNELSE</b>	
FI	<b>SISÄLLYSLUETTELO</b>	

<b>Maintenance/skötsel/vedlikehold/vedligeholdelse/hoito</b>	<b>3</b>
<b>Tools/verktyg/verktøy/værktøjer/työkalut</b>	<b>4</b>
<b>Components/komponenter/komponentit</b>	<b>5</b>
<b>Assembly/montering/montage/kokoonpano</b>	<b>7</b>



Copyright ©2020 Bygghemma Sverige AB. Original content rights reserved. All product names, logos, and brands are property of their respective owners.



Information contained within this document was considered accurate at the time of publication, but may be subject to revision.



- EN **Hire licensed professionals** when appropriate.  
 SV **Anlita licensierade hantverkare** när så krävs.  
 NO **Leie lisensierte lisensierte fagfolk** når det er nødvendig.  
 DK **Leje licenserede autoriserede fagfolk** når det kræves.  
 FI **Vuokra llisensoidut ammattilaiset** tarvittaessa.

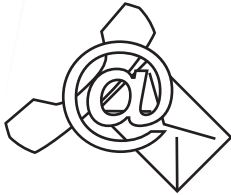

- EN **If you have questions**, please contact us.  
 SV **Om du har frågor**, vänligen kontakta oss.  
 NO **Hvis du har spørsmål**, om produktet eller manualen.  
 DK **Hvis du har spørgsmål**, til dette produkt eller manual.  
 FI **Jos sinulla on kysyttävää**, ota yhteyttä.

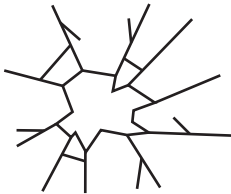

- EN **If any part is broken**, do not use the product before repairing it.  
 SV **Om någon del är defekt**, åtgärda detta innan produkten brukas.  
 NO **Hvis noen del er ødelagt**, ikke bruke produktet før reparasjoner.  
 DK **Hvis nogen del er brudt**, ikke bruge produktet før du reparerer det.  
 FI **Jos jokin osa on rikki**, älä käyttää tuotetta ennen sen korjaamista.



- EN **When cleaning**, do not use bleaching or abrasive chemicals.  
 SV **Vid rengöring**, använd inte blekande eller slipande kemikalier.  
 NO **Ved rengjøring**, ikke bruk blekemidler eller slitende kjemikalier.  
 DK **Ved rengøring**, brug ikke blegemidler eller slibende kemikalier.  
 FI **Kun puhdistat**, älä käyttää valkaisu- tai hankaavia kemikaaleja.



- EN Notice height differences  
 SV Tänk på höjdskillnader  
 NO Tenk på høydeforskjeller  
 DK Tænk på højdeforskelle  
 FI Ajattele korkeuseroja



- EN Notice pinching risks  
 SV Tänk på klämrisiker  
 NO Tenk på klemt risiko  
 DK Tænk på at klemme risici  
 FI Ajattele riskien puristamista



- EN Keep carton indoors  
 SV Förvara lådan inomhus  
 NO Hold boksen innendørs  
 DK Hold kassen indendørs  
 FI Pidä laatikko sisätiloissa



Copyright ©2020 Bygghemma Sverige AB. Original content rights reserved. All product names, logos, and brands are property of their respective owners.



Information contained within this document was considered accurate at the time of publication, but may be subject to revision.

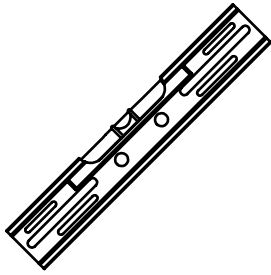

EN Spirit-level  
 SV Vattenpass  
 NO Vaterpass  
 DK Vaterpas  
 FI Vatupassi

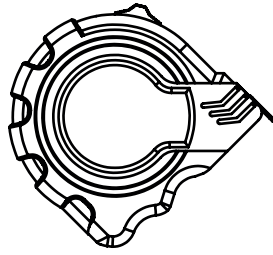

EN Measure tape  
 SV Måttband  
 NO Måletape  
 DK Målebånd  
 FI Iskuporakone

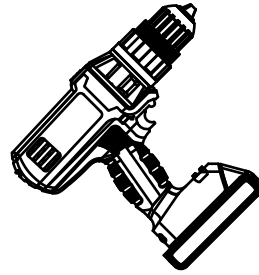

EN Drill  
 SV Borr  
 NO Bor  
 DK Bore  
 FI Porakone

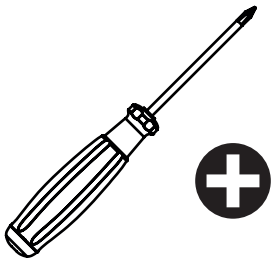

EN Screw Driver  
 SV Skruvmejsel  
 NO Skrutrekker  
 DK Skruetrækker  
 FI Ruuvimeisseli

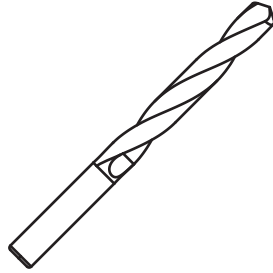

EN Drill Head  
 SV Borr  
 NO Borr  
 DK Bor  
 FI Poranterä

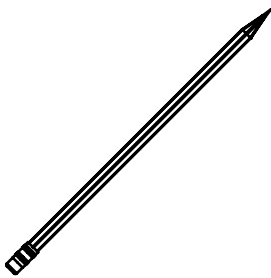

Pen/penn/penna/  
 kynä

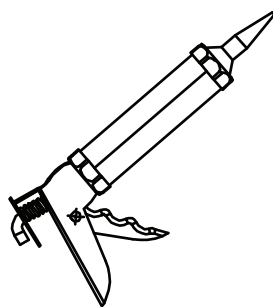

EN Silicone gun  
 SV Silikonspruta  
 NO Silikonsprøyte  
 DK Silikone Sprøjte  
 FI Silikoniruisku

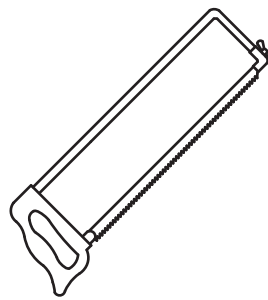

EN Saw  
 SV Såg  
 NO Sag  
 DK Sav  
 FI Saha



Copyright ©2020 Bygghemma Sverige AB. Original content rights reserved. All product names, logos, and brands are property of their respective owners.





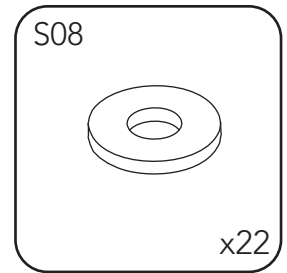
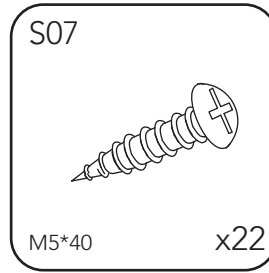
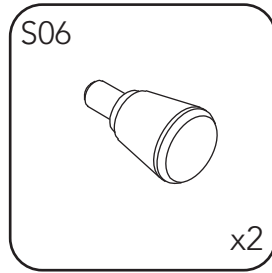
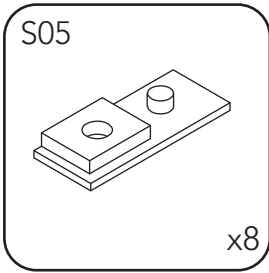
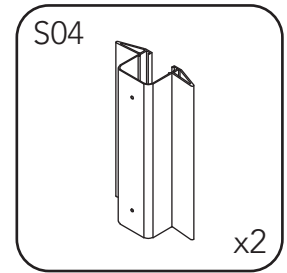
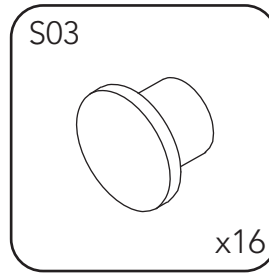
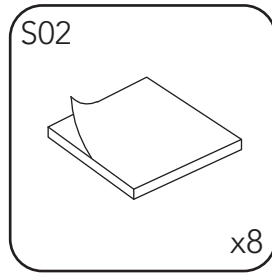
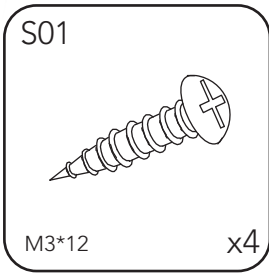
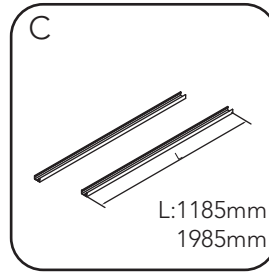
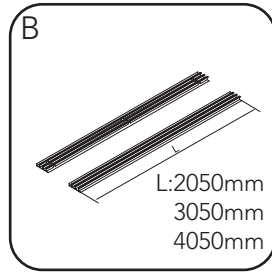
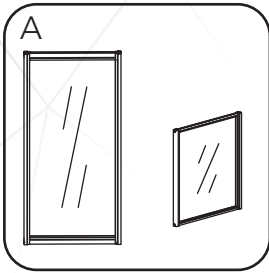

Information contained within this document was considered accurate at the time of publication, but may be subject to revision.



Copyright ©2020 Bygghemma Sverige AB. Original content rights reserved. All product names, logos, and brands are property of their respective owners.

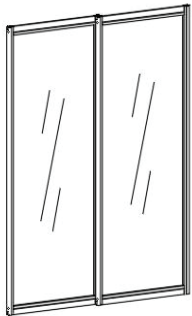

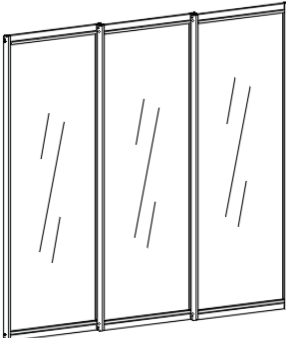
Information contained within this document was considered accurate at the time of publication, but may be subject to revision.

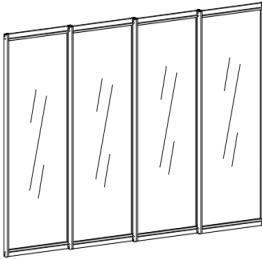
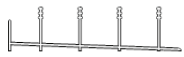
Wall Dimension		Door/Window Selection				Track Cutting	
Door/Window Height(mm)	Door/Window Width(mm)	740	840	940	1040	Original Length(mm)	Cut Distance(mm)
1200 / 2000							
	1450	2				 2050	1450 (cut <b>300</b> mm on <b>each side</b> )
	1550	1	1				1550 (cut <b>250</b> mm on <b>each side</b> )
	1650		2				1650 (cut <b>200</b> mm on <b>each side</b> )
	1750		1	1			1750 (cut <b>150</b> mm on <b>each side</b> )
	1850			2			1850 (cut <b>100</b> mm on <b>each side</b> )
	1950			1	1		1950 (cut <b>50</b> mm on <b>each side</b> )
	2050				2		2050 (cut <b>0</b> mm on <b>each side</b> )
	2150	3				 3050	2150 (cut <b>450</b> mm on <b>each side</b> )
	2250	2	1				2250 (cut <b>400</b> mm on <b>each side</b> )
	2350	1	2				2350 (cut <b>350</b> mm on <b>each side</b> )
	2450		3				2450 (cut <b>300</b> mm on <b>each side</b> )
	2550		2	1			2550 (cut <b>250</b> mm on <b>each side</b> )
	2650		1	2			2650 (cut <b>200</b> mm on <b>each side</b> )
	2750			3			2750 (cut <b>150</b> mm on <b>each side</b> )
	2850			2	1		2850 (cut <b>100</b> mm on <b>each side</b> )
	2950			1	2		2950 (cut <b>50</b> mm on <b>each side</b> )
	3050				3		3050 (cut <b>0</b> mm on <b>each side</b> )
	3150	1	3			 4050	3150 (cut <b>450</b> mm on <b>each side</b> )
	3250		4				3250 (cut <b>400</b> mm on <b>each side</b> )
	3350		3	1			3350 (cut <b>350</b> mm on <b>each side</b> )
	3450		2	2			3450 (cut <b>300</b> mm on <b>each side</b> )
	3550		1	3			3550 (cut <b>250</b> mm on <b>each side</b> )
	3650			4			3650 (cut <b>200</b> mm on <b>each side</b> )
	3750			3	1		3750 (cut <b>150</b> mm on <b>each side</b> )
	3850			2	2		3850 (cut <b>100</b> mm on <b>each side</b> )
	3950			1	3		3950 (cut <b>50</b> mm on <b>each side</b> )
	4050				4		4050 (cut <b>0</b> mm on <b>each side</b> )



Copyright ©2020 Bygghemma Sverige AB. Original content rights reserved. All product names, logos, and brands are property of their respective owners.



Information contained within this document was considered accurate at the time of publication, but may be subject to revision.



1

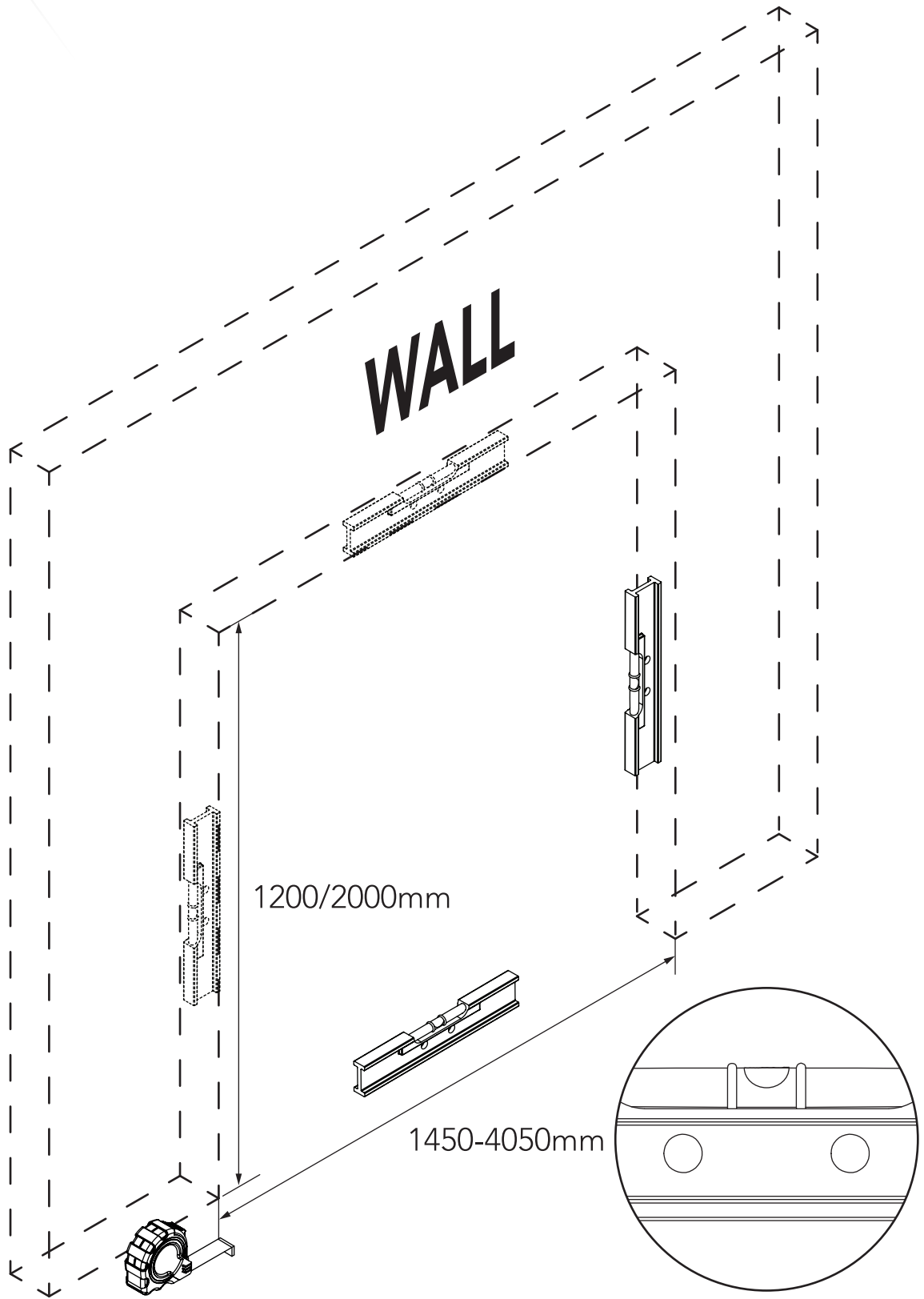

Copyright ©2020 Bygghemma Sverige AB. Original content rights reserved. All product names, logos, and brands are property of their respective owners.



Information contained within this document was considered accurate at the time of publication, but may be subject to revision.

2

x2

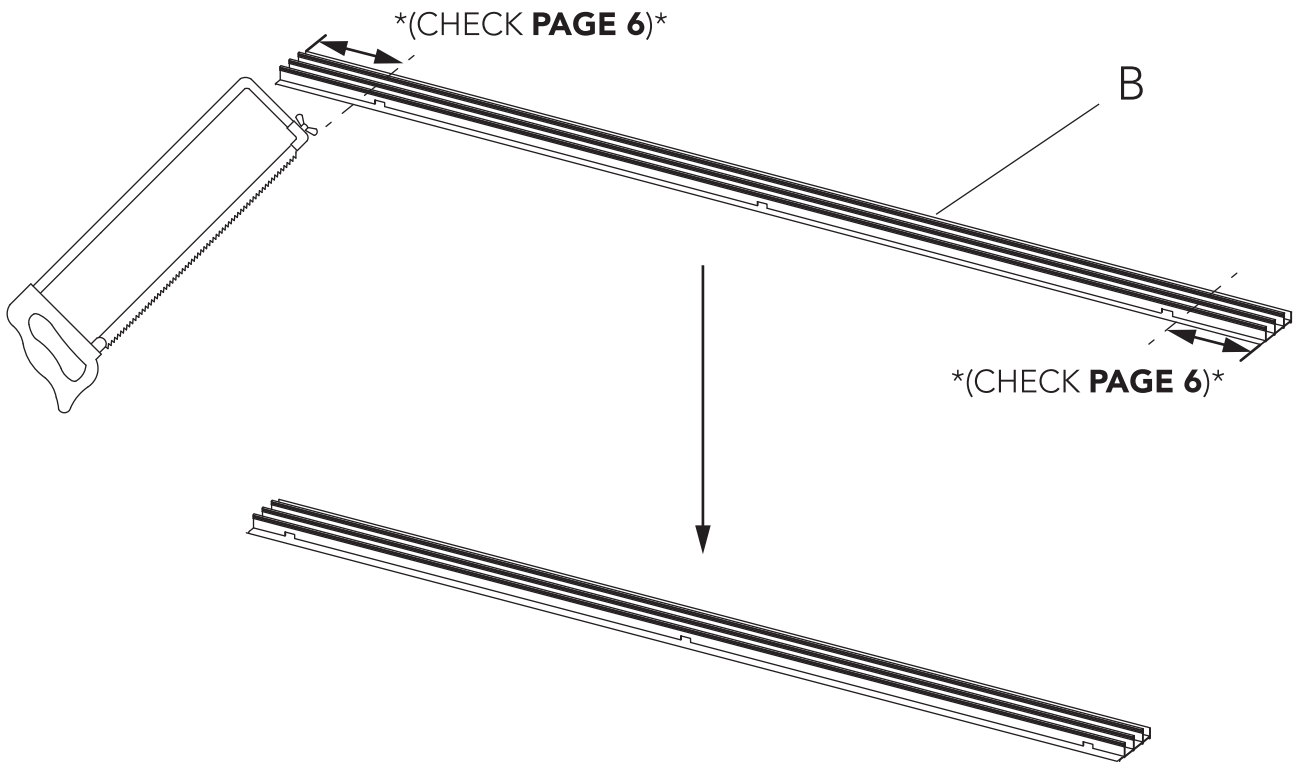

Copyright ©2020 Bygghemma Sverige AB. Original content rights reserved. All product names, logos, and brands are property of their respective owners.



Information contained within this document was considered accurate at the time of publication, but may be subject to revision.



3

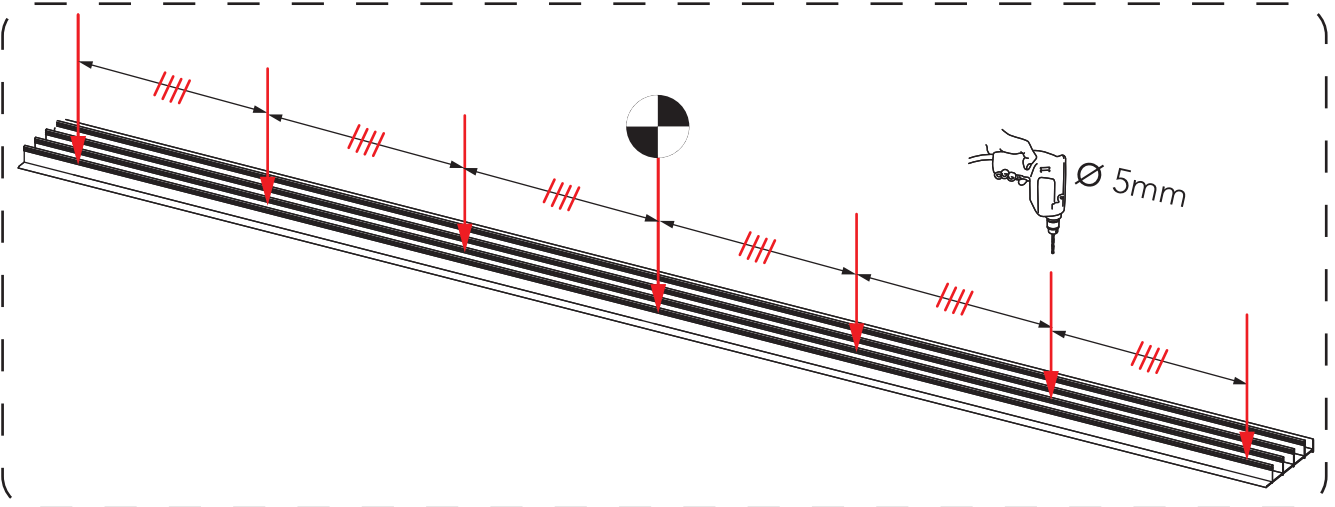
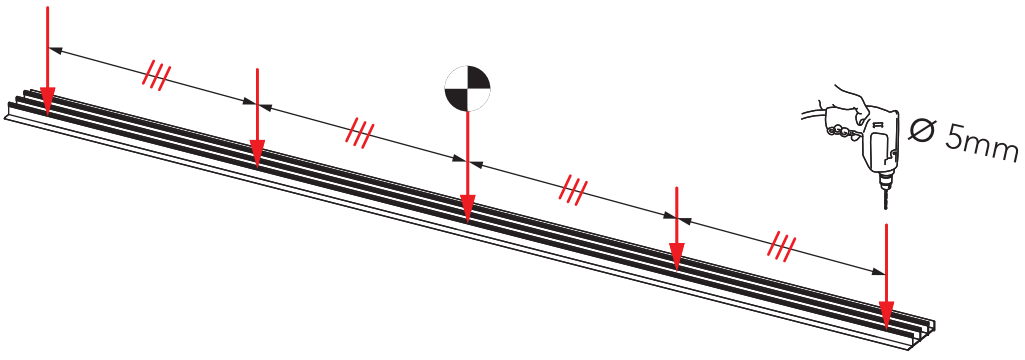
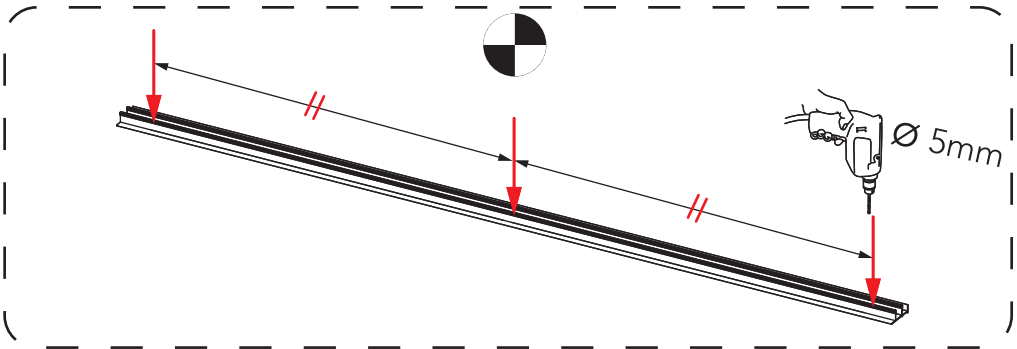
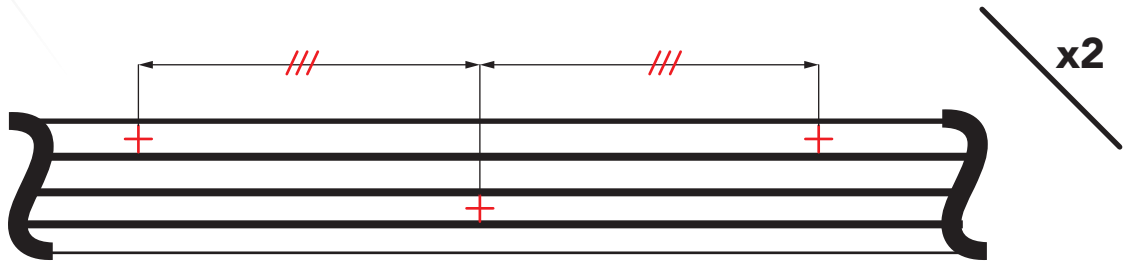

Copyright ©2020 Bygghemma Sverige AB. Original content rights reserved. All product names, logos, and brands are property of their respective owners.



Information contained within this document was considered accurate at the time of publication, but may be subject to revision.

4

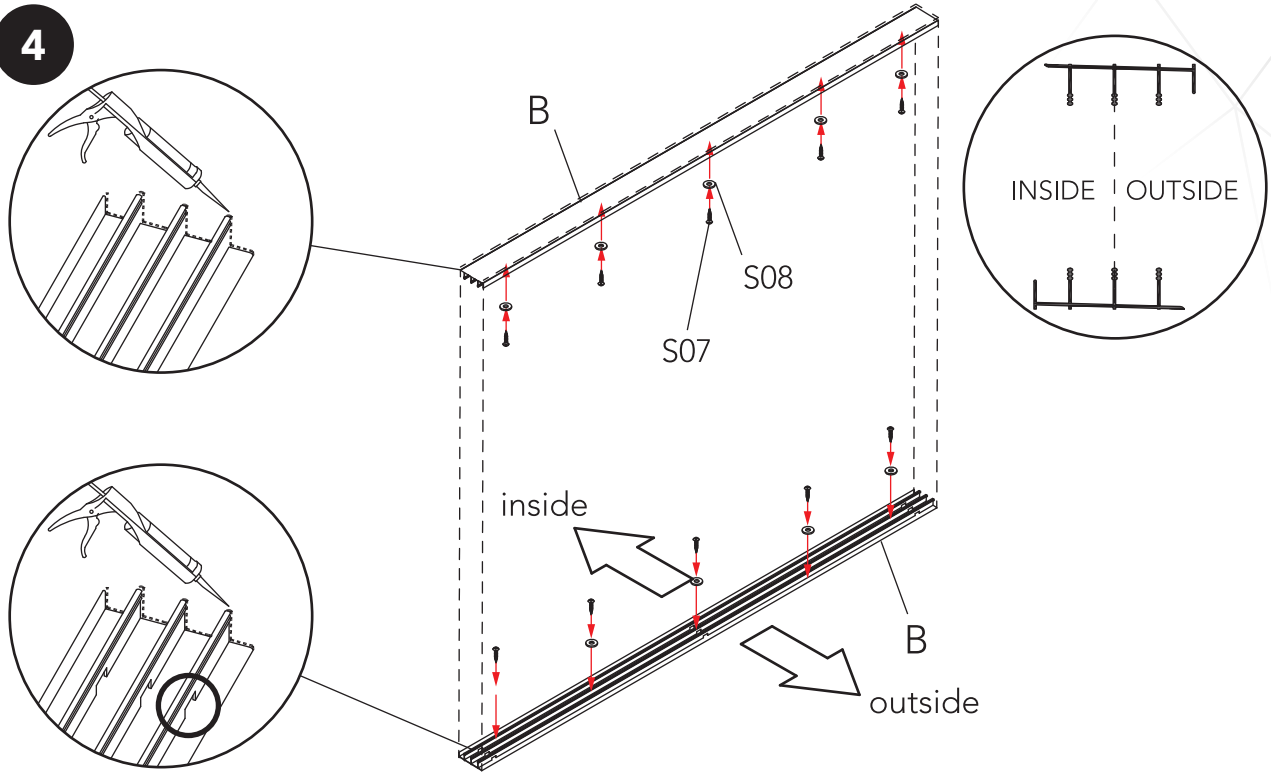

5

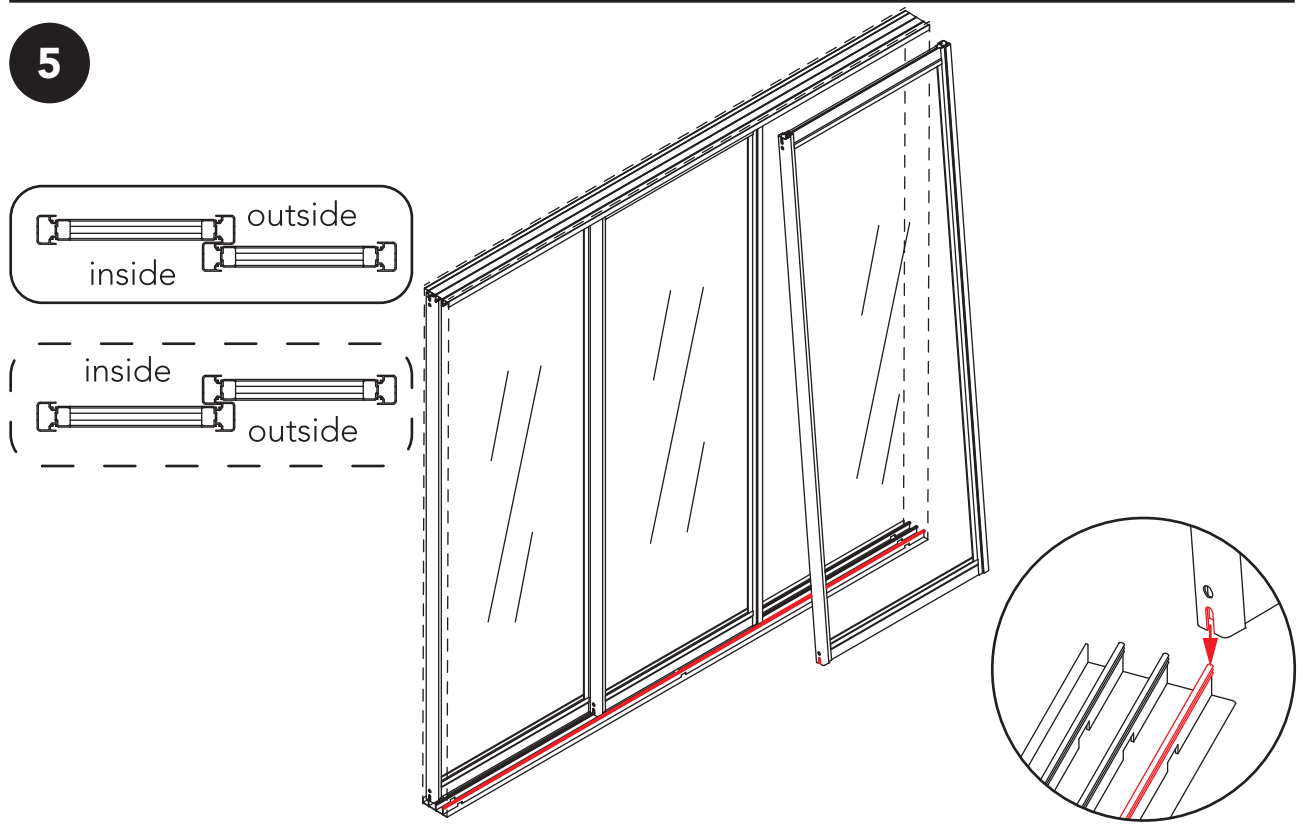

Copyright ©2020 Bygghemma Sverige AB. Original content rights reserved. All product names, logos, and brands are property of their respective owners.



Information contained within this document was considered accurate at the time of publication, but may be subject to revision.

6

x2

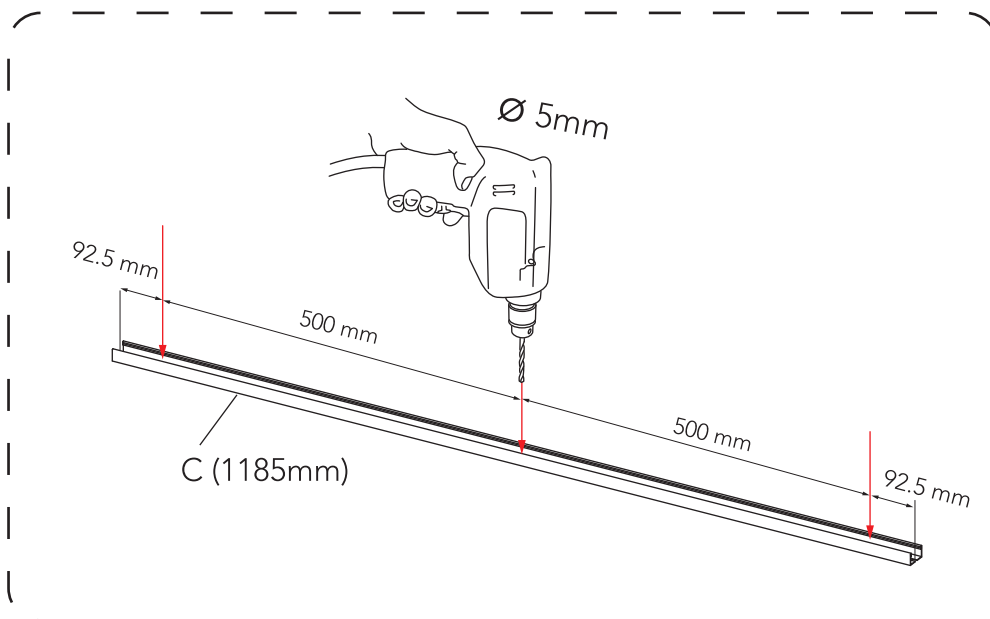
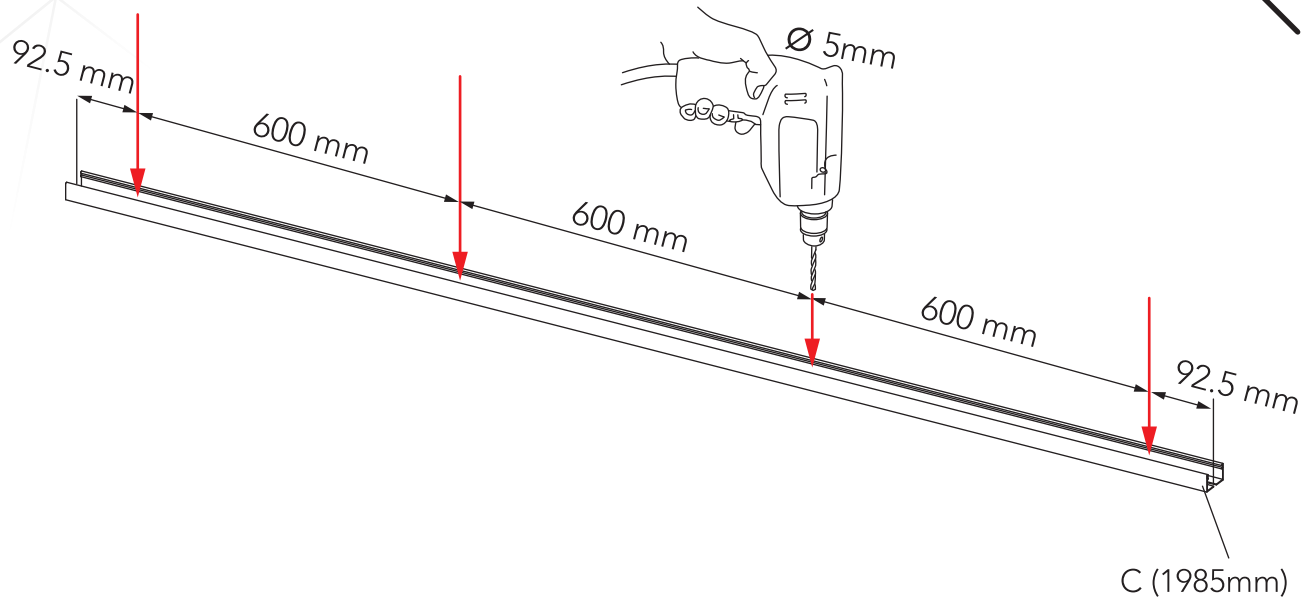

Copyright ©2020 Bygghemma Sverige AB. Original content rights reserved. All product names, logos, and brands are property of their respective owners.



Information contained within this document was considered accurate at the time of publication, but may be subject to revision.

7

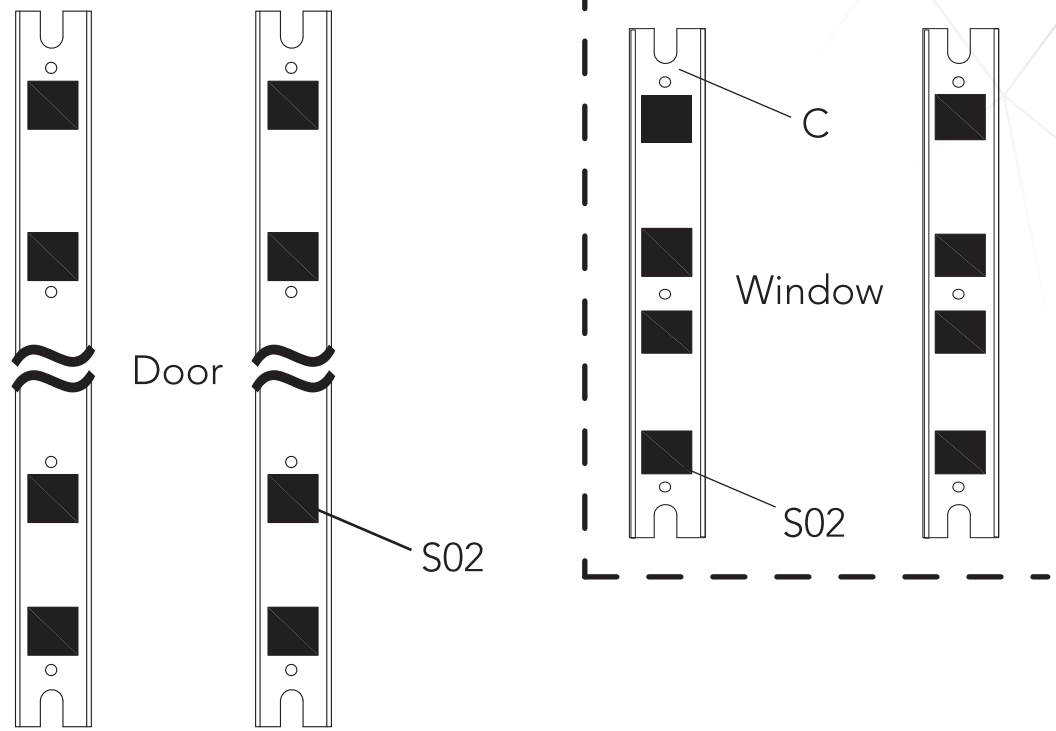

8

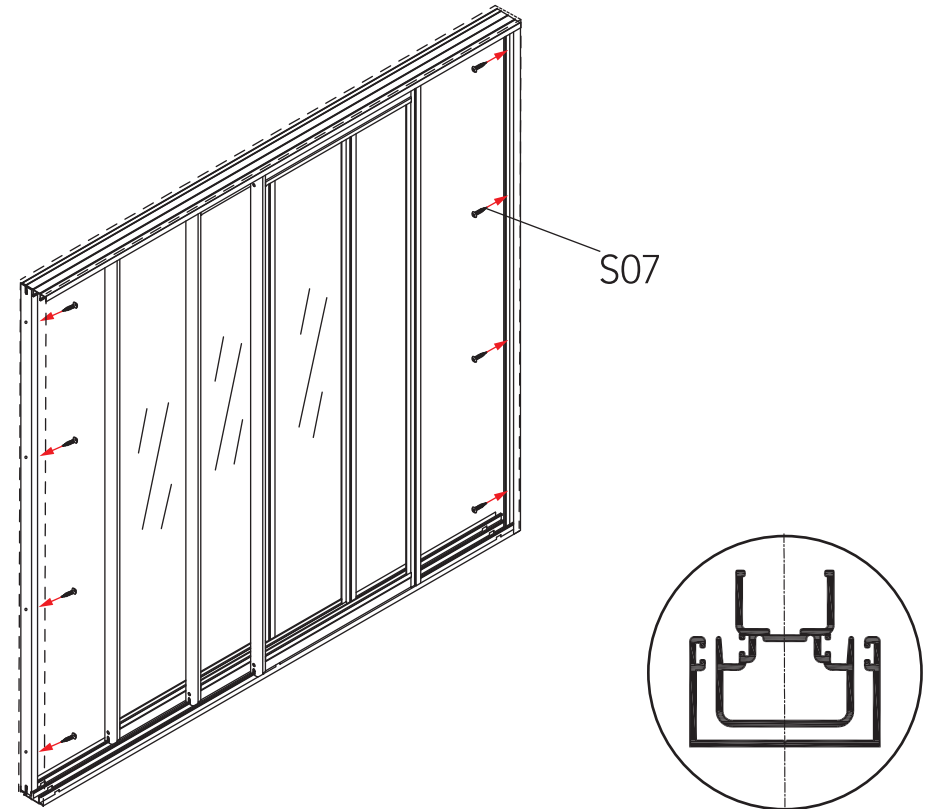

Copyright ©2020 Bygghemma Sverige AB. Original content rights reserved. All product names, logos, and brands are property of their respective owners.



Information contained within this document was considered accurate at the time of publication, but may be subject to revision.

9

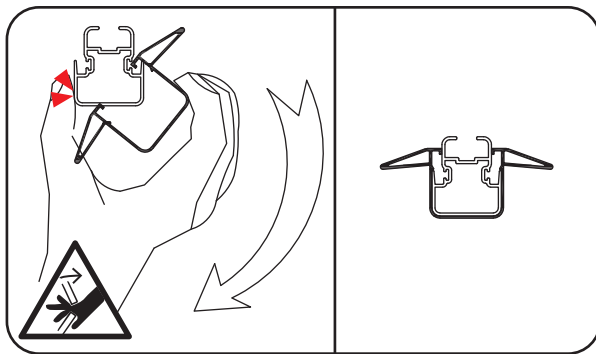

S04

Door : 100cm  
Window : 15cm

x2

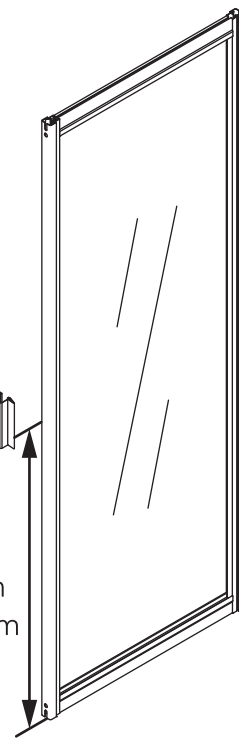

10

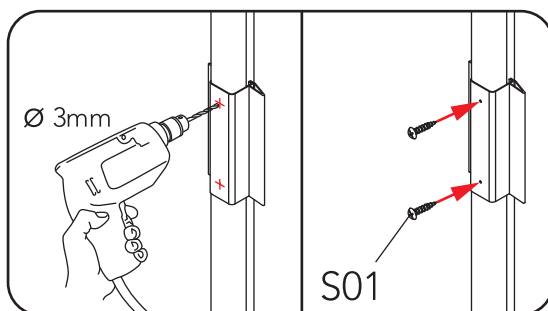

S01

x2

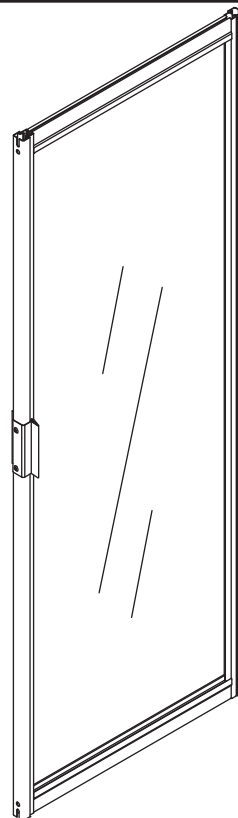

Copyright ©2020 Bygghemma Sverige AB. Original content rights reserved. All product names, logos, and brands are property of their respective owners.



Information contained within this document was considered accurate at the time of publication, but may be subject to revision.

11

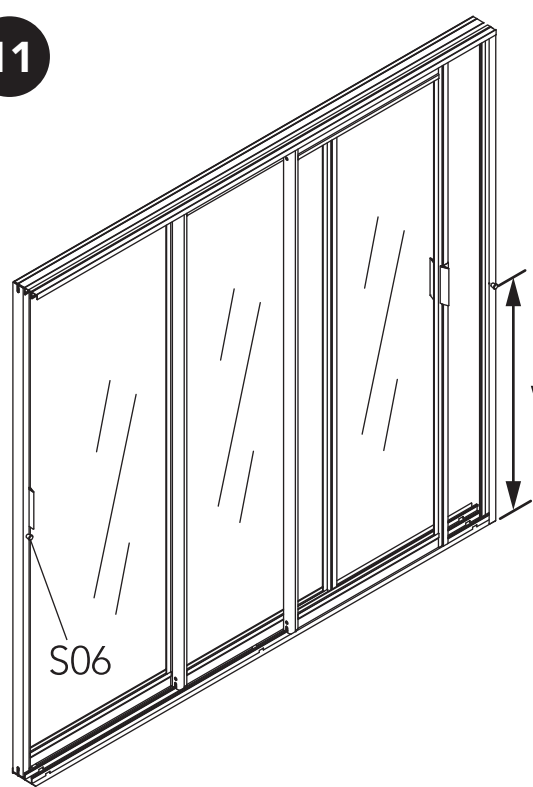

Door : 95cm  
Window : 10cm

x2

15mm

Ø 3mm  
Ø 6mm  
Ø 9mm

S06

12

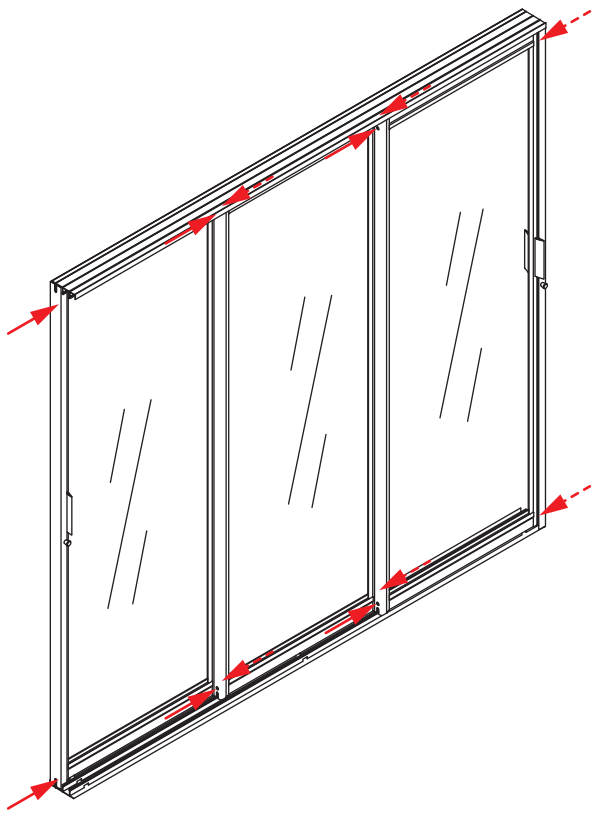
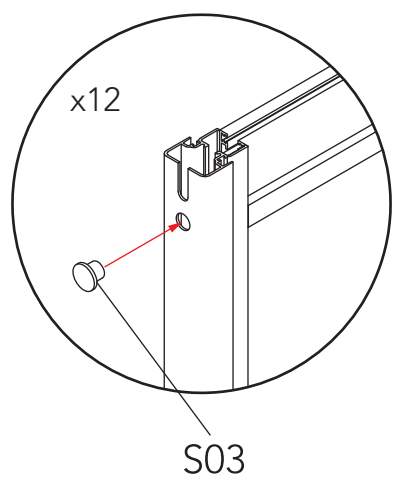

Copyright ©2020 Bygghemma Sverige AB. Original content rights reserved. All product names, logos, and brands are property of their respective owners.



Information contained within this document was considered accurate at the time of publication, but may be subject to revision.

13

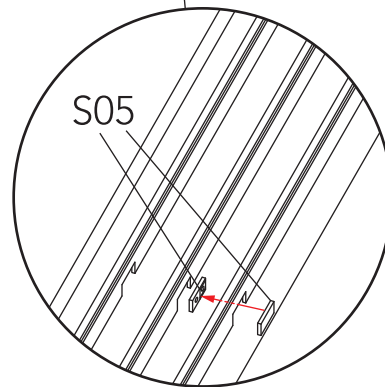
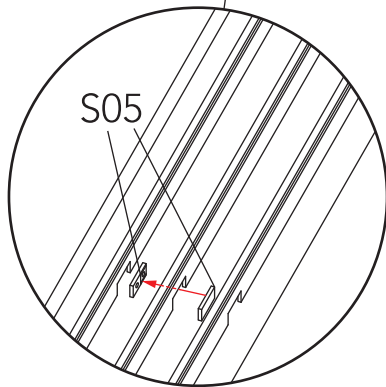
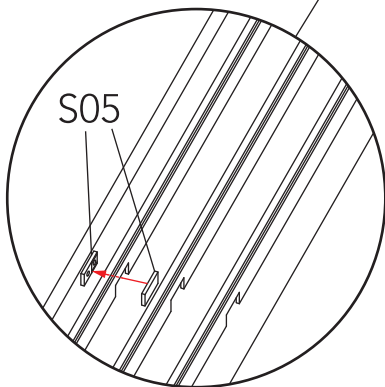
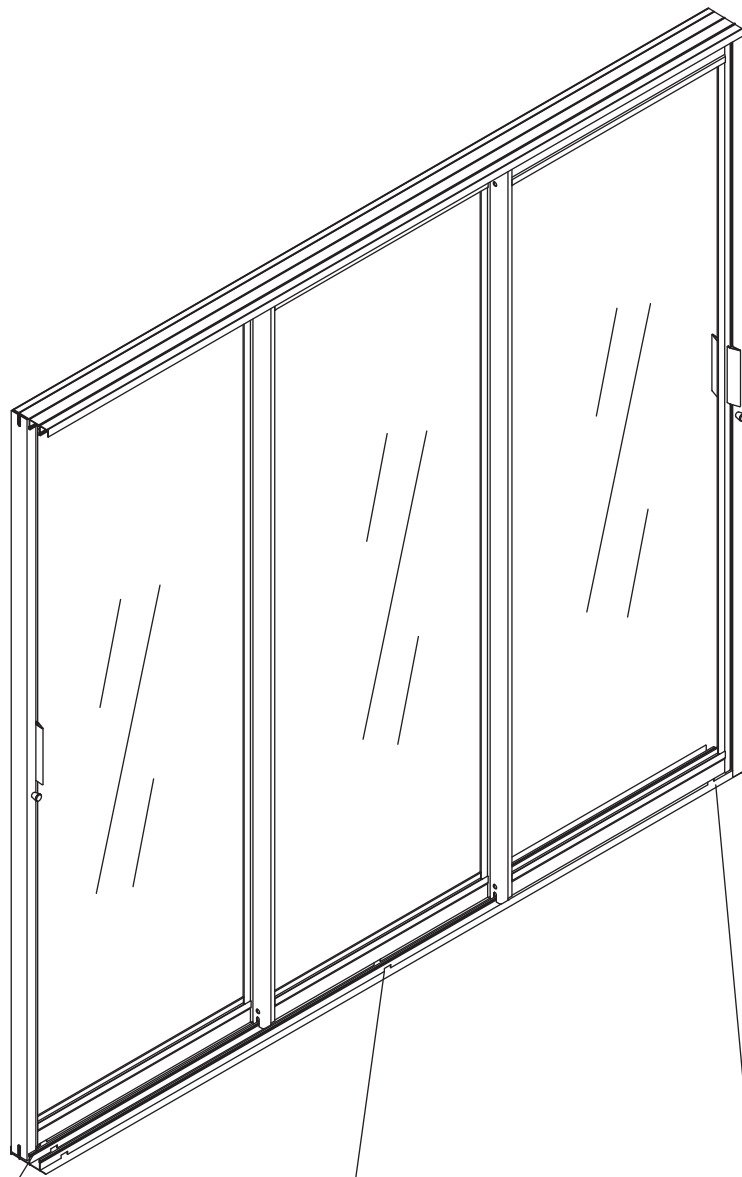

Copyright ©2020 Bygghemma Sverige AB. Original content rights reserved. All product names, logos, and brands are property of their respective owners.



Information contained within this document was considered accurate at the time of publication, but may be subject to revision.

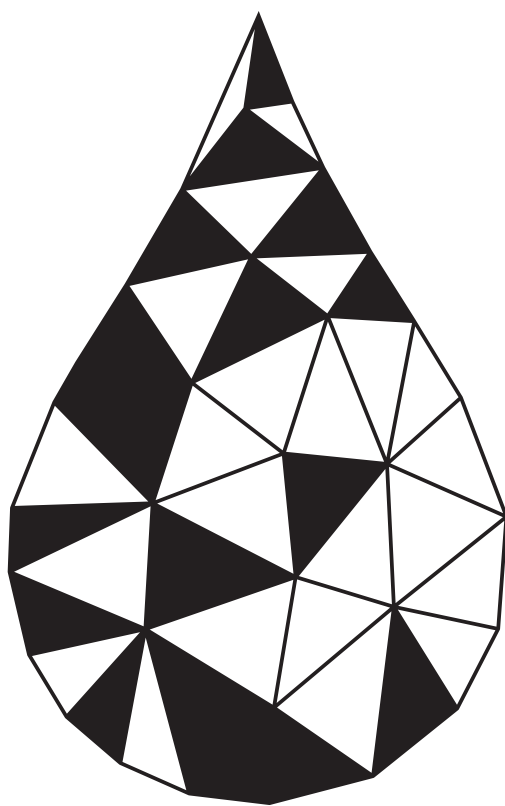

Copyright ©2020 Bygghemma Sverige AB. Original content rights reserved. All product names, logos, and brands are property of their respective owners.



Information contained within this document was considered accurate at the time of publication, but may be subject to revision.